

3Ø22kV

Oil Immersed Transformer

Technical Data

Applicable Standards	AS2374
Frequency	50Hz
Insulation Class	A
Oil/Winding Temperature Level	55°C
Rated Voltage & Connection	HV 22kV Delta LV 415V Wye
Average Sound Level	NEMA TR1

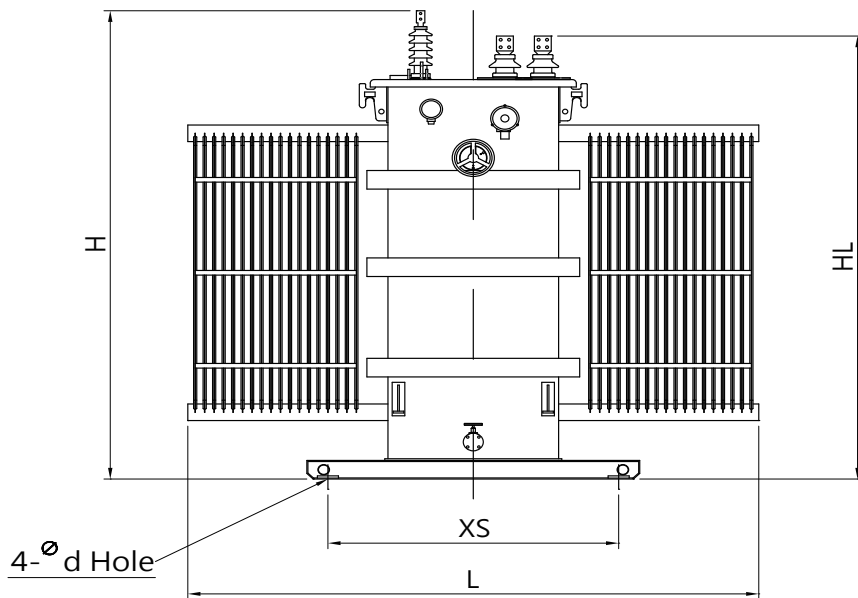
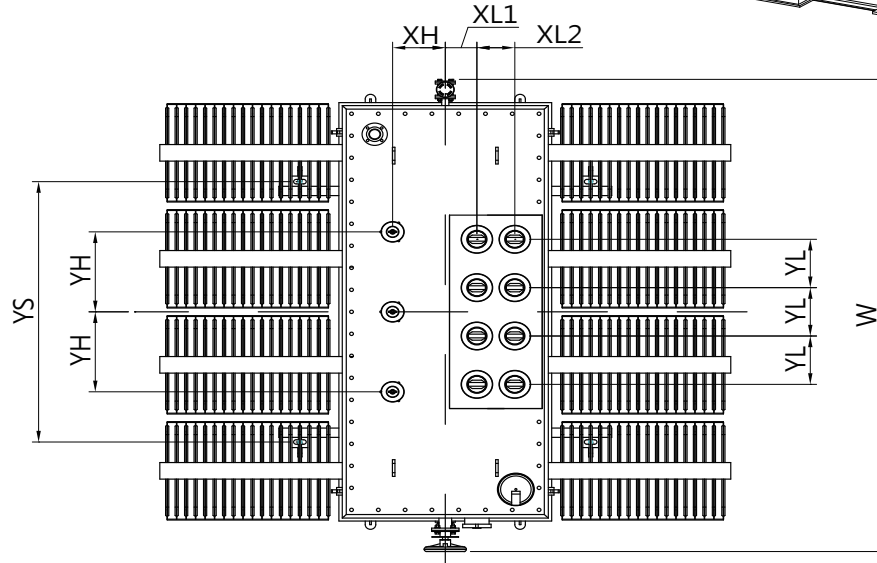
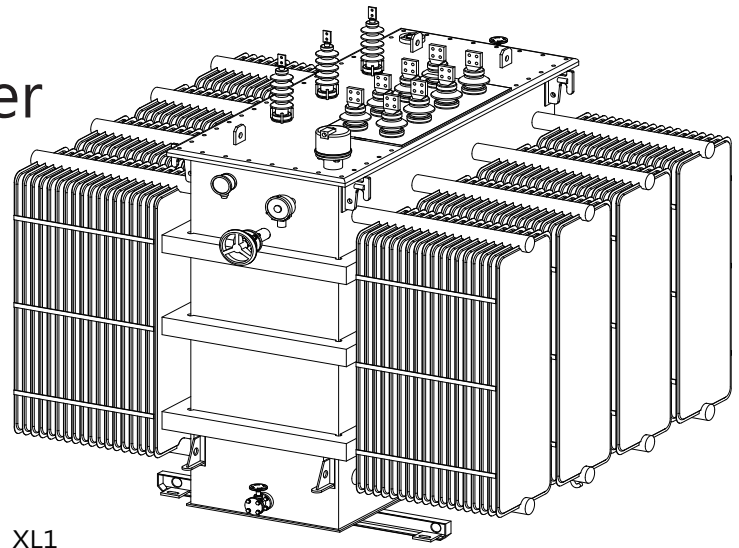

Technical Data & Dimensions

Rated Voltage	Phase NO.	Rating (kVA)	Standard																Terminal		
			Efficiencies (PF=1.0) (%)	Total Loss (W)	Impedance (%)	Dimension(mm)				Foundation Distance(mm)			Bushing distance(mm)				Oil (l)	Weight (kg)	HV	LV	
						L	W	H	HL	XS	YS	d	XH	XL1	XL2	YH					YL
22kV	3	4000	98.94	42700	5.5~6.5	2810	2670	2445	2290	1460	1460	24	250	50	180	300	240	2800	12200	NO.1	NO.5
		5000	98.98	51700	5.5~6.5	3200	2830	2595	2510	1600	1540	24	250	50	200	300	240	3530	14500		NO.6

